



Vegetable slicer #48 (high output)

Heavy Duty Construction
High Output
Attractive price
(delivered with 3 standard discs)



Internationally Patented Models





Vegetable

Ideal for everyday preparations

- The vegetable slicer #48 is a **robust** appliance adapted to **intensive use**.
- Dedicated to restaurants, institutions, fast foods, pizzerias, snack shops, sandwich bars...
- The appliance is **delivered with 3 discs** (T3, R3 and E8)
- A wide range of discs is available in option to cut, slice, grate and shred
- **Easy to use**: feeding hopper with a plastic pusher, easy to open for changing the disc and cleaning, brake when opening (safety)
- **High output**: the disc is directly driven by the 1000 rpm motor

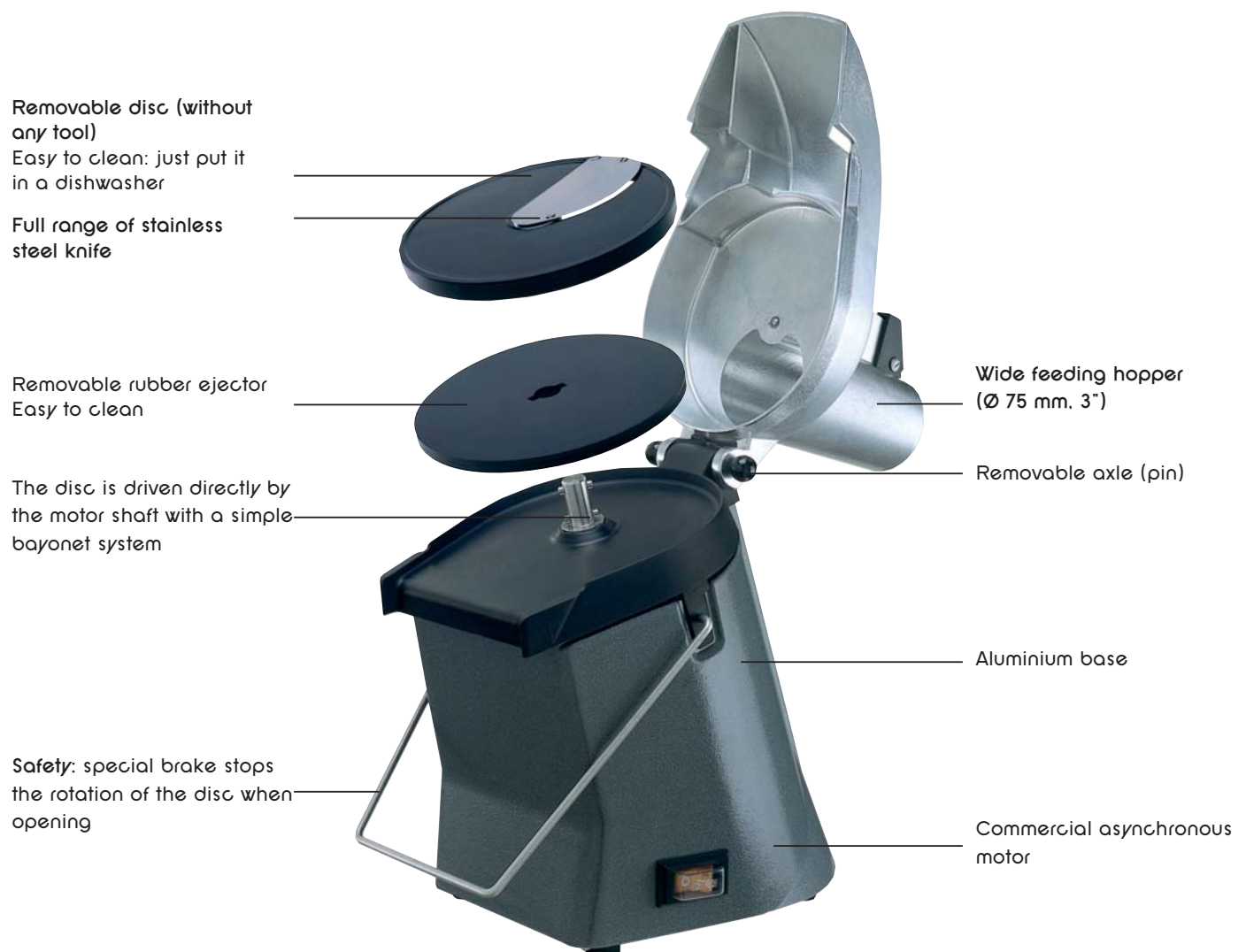

3 discs supplied with the appliance:
Slicer T3 / Grater R3 / Shredder E8





slicer #48 (with high output)

A complete range of discs to slice, grate and shred...



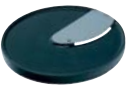

www.santos.fr

SLICING DISCS

Ref.	Discs	Thickness	Functions	Applications
T1		1	Thin slicing	Disc with smooth knife for: - Potatoes : chips, thin slices, gratin.
T2		2	Slicing	- Carrots, onions, tomatoes, turnips, cabbages, radishes.
T3		3	Slicing	- Cucumbers, aubergines, courgettes, peppers.
T4		4	Cutting	- Celery, endives, leeks, mushrooms.
T5		5	Cutting	- Apples, bananas, oranges, lemons.
T6		6	Thick cutting	- Cheeses. - Dry sausages, meat pies. - Bread
TD4		4	Cutting	Disc with special serrated knife for : Cutting very soft food like tomatoes or other vegetables or fruits with hard peel and fragile inside : peppers, courgettes, oranges, lemons
TD6		6	Thick cutting	
TO4		4	Ondulated cutting	Disc with special ondulated (crinkled) knife for : Crinkled potatoes, carrots, beetroots (scallop cutting)

GRATING DISCS

R2		Ø 2	Thin grating	Grating disc for : Cheeses : Gruyere cheese, emmenthal, comté, cheddar, pizza cheese
R3		Ø 3	Grating	Grating, shredding, julienne - Grated carrots, celery (remoulade), - Straw potatoes, red cabbage, beetroot, turnip, radish
R4		Ø 4	Grating	- Almonds, nuts, walnuts, chocolate. - Breadcrumbs from dry bread
RP		Powder	Powder grating	Special grating disc for parmesan, hard cheese. Also for : - Almonds, nuts, walnuts, chocolate. - Breadcrumbs from dry bread
RR		Rösti	Grating	Special grating disc for rösti. - Potato pancakes

SHREDDING DISCS

E2		2 x 2	Thin shredding	Shredding discs for : - Julienne, potatoes (shoestring fries), celery (remoulade), carrots strips. - French fries (slightly curved)
E4		4 x 4	Shredding	
E8		8 x 8	Thick shredding (French fries)	

To order an additional disc: 48200 + Reference
Example: 4mm thickness slicer = 48200T4 or
Parmesan grater = 48200RP

Technical specifications

Motor

- Single phase:
100-120 V - 50/60 Hz - 450 W - CE-UL-NSF
220-240 V - 50/60 Hz - 390 W - CE-GS
- Vitesse : 1000 RPM (50Hz)
1200 RPM (60 HZ)

Weight

- Net: 17 kg (37 lbs)
- Shipping: 19 kg (42 lbs)

Appliance:

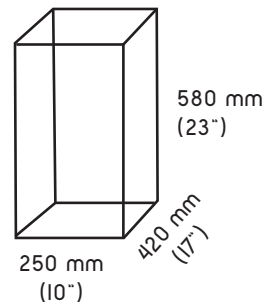

Shipping box:

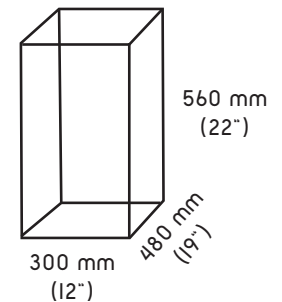

Safety - Standards - Hygiene

In accordance with the following regulations:

- ◆ Machinery directive 2006/42/EC
- ◆ Electromagnetic compatibility 2004/108/EC
- ◆ "Low voltage" directive 2006/95/EC
- ◆ RoHS directive 2002/95/EC
- ◆ Regulation 1935/2004/EC Contact with food

Harmonized European standards :

- ◆ EN ISO 12100-1 and 2: 2004
- ◆ EN 60204-1: 2006
- ◆ EN 1678-1: 2010 Food processing machinery - Vegetable cutting machines
- ◆ EN 60335-2-64 :2004 Commercial electric kitchen machines
- ◆ CE (Europe), UL (USA) et cUL (Canada), NSF (USA)
- ◆ GS (Germany) checked by the LNE (National Test Laboratory)

Hygiene:

All removable parts can be put in a dishwasher or easily cleaned with hot soapy water.

Motor safety:

Motor protected by overload and thermal protectors

PRODUCT: 2-YEAR WARRANTY - MOTOR: 5-YEAR WARRANTY

